



Version : *Preliminary*

TECHNICAL SPECIFICATION

MODEL NO. : PW070DS1T1

Customer's Confirmation

Date _____

By _____

PVI's Confirmation

Confirmed By _____

Prepared By _____

PRIME VIEW INTERNATIONAL CO.,LTD.
3,LI SHIN RD. 1,SCIENCE-BASED INDUSTRIAL
PARK,HSINCHU,TAIWAN,R.O.C.
<http://www.pvi.com.tw>

Date : FEB. 02,2000

This technical specification is subject to change without notice.
Please return 1 copy with your signature on this page for approval.

TECHNICAL SPECIFICATION

CONTENTS

NO.	ITEM	PAGE
-	Cover(P70AN1)	1
-	Contents	2
1	Application	3
2	Features	3
3	Mechanical Specifications	3
4	Mechanical Drawing of TFT-LCD module	4
5	Input / Output Terminals	5
6	Absolute Maximum Ratings	7
7	Electrical Characteristics	7
8	Power Sequence	21
9	Optical Characteristics	22
10	Reliability Test	25
11	Block Diagram	26
12	Packing	27
-	Revision History	28

1. Application

This technical specification applies to 7.0" color TFT-LCD module, P70AN1. The applications of the panel are car TV, portable DVD, GPS, multimedia applications and others AV system.

2. Features

- . Pixel in stripe configuration
- . Slim and compact
- . High Brightness
- . Image Reversion : Up/Down and Left/Right
- . 8 Video Display Mode

3. Mechanical Specifications

Parameter	Specifications	Unit
Screen Size	7.0 (16:9 diagonal)	inch
Display Mode	Normally White	
Display Format	1440(H)×234(V)	dot
Active Area	154.08 (H)×87.048 (V)	mm
Dot Pitch	0.107(H)×0.372 (V)	mm
Pixel Configuration	Stripe	
Outline Dimension	166.9 (W)×101.8 (H)×12.05 (D)	mm
Surface Treatment	Anti-Glare and Hard Coating	
Weight	200	g

4. Mechanical Drawing of TFT-LCD Module

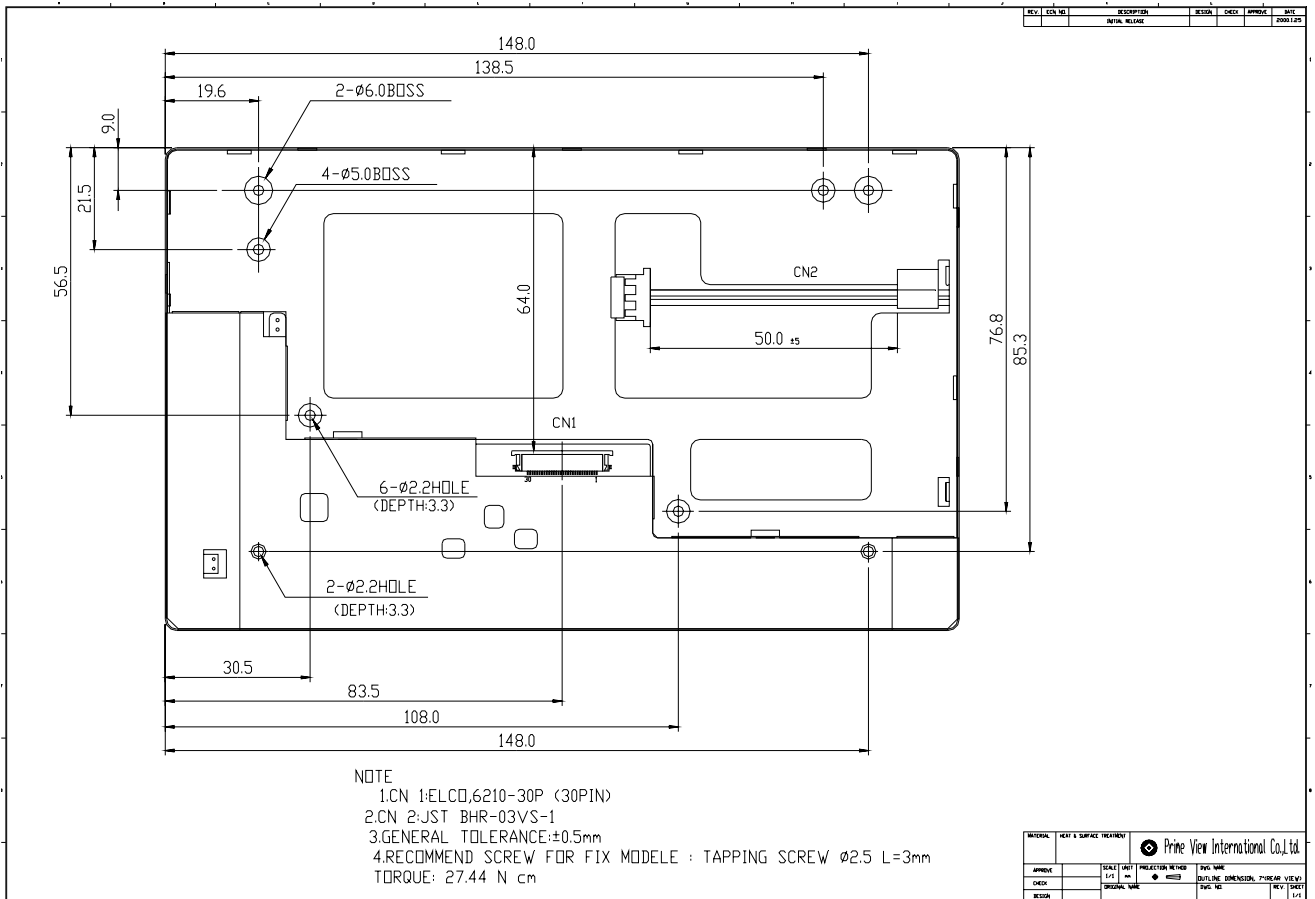
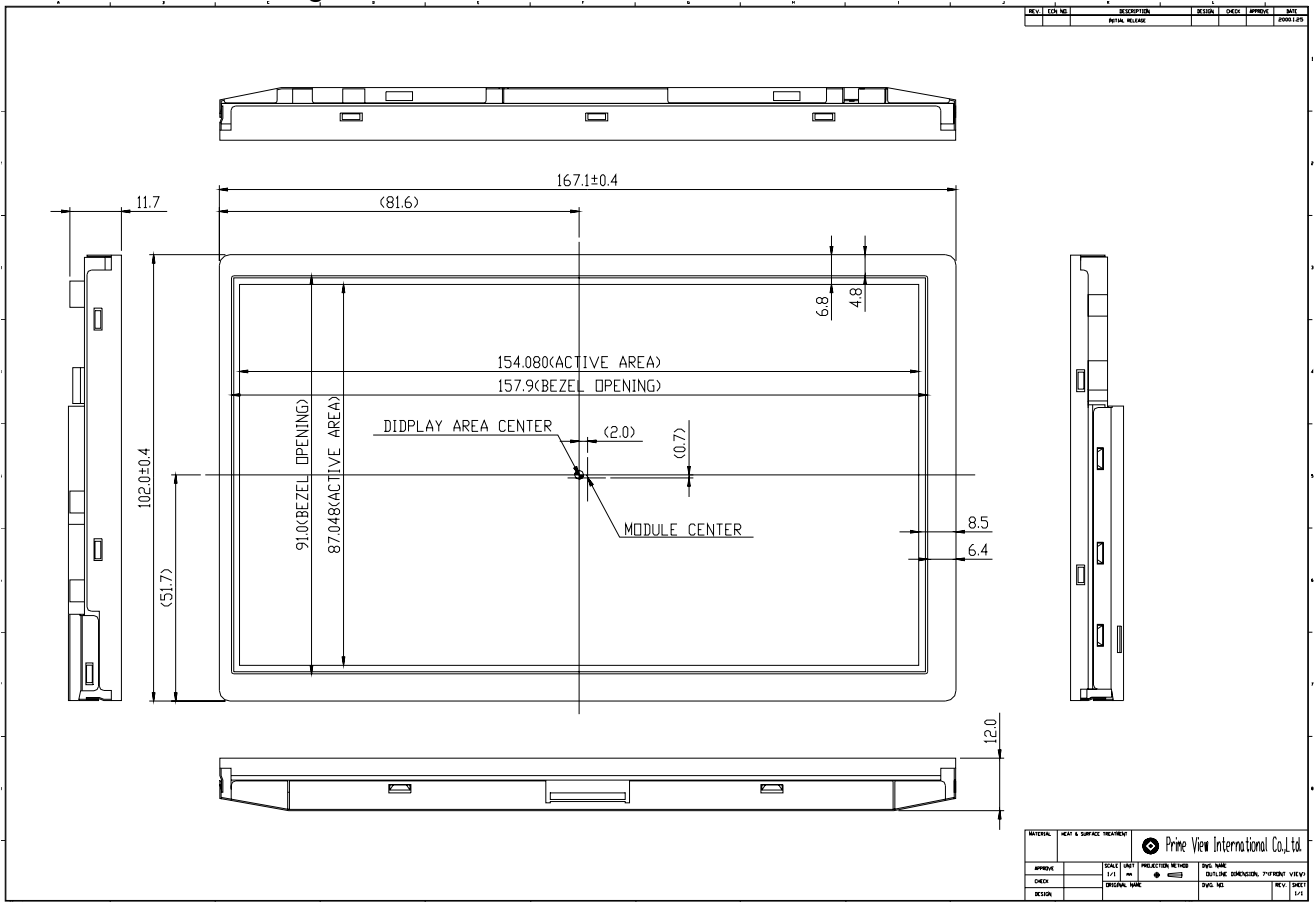

The information contained herein is the exclusive property of Prime View International Co., Ltd. and shall not be distributed, reproduced, or disclosed in whole or in part without prior written permission of Prime View International Co., Ltd. PAGE:4

5. Input / Output Terminals
5-1) TFT-LCD Panel Driving

The interface connector is 6210-30P Series manufactured by ELCO or equivalent. (0.5mm pitch 30 pin)

The connector interface pin assignments are listed in the Table below.

Pin No	Symbol	Description	Remark
1	NC	No Connection	
2	RED	Red Video Input	
3	GREEN	Green Video Input	
4	BLUE	Blue Video Input	
5	GND	Ground	
6	CSY	Composite Sync Input	
7	NC	No Connection	
8	NC	No Connection	
9	NC	No Connection	
10	NC	No Connection	
11	MODE 1	Display Mode Selection Switch (Refer to 5.2)	
12	MODE 2		
13	MODE 3		
14	GND	Ground	
15	BLK	Video Signal Mask Timing Output	
16	HSY	Horizontal Sync Output	
17	VSX	Vertical Sync Output	
18	VCC	Input Voltage For Logic/Logic Voltage For Source Driver	Note:5-1
19	POLS	Video Polarity Control Signal	
20	POLC	VCOM Polarity Control Signal	
21	GND	Ground	
22	U/D	Scanning Direction : (Low : Normal , High : Reverse)	
23	L/R	Scanning Direction : (Low : Normal , High : Reverse)	
24	N/P	NTSC/PAL Selection Signal(Low : PAL , High : NTSC)	
25	VD	Vertical Sync Input	Note:5-2
26	HD	Horizontal Sync Input	Note:5-2
27	GND	Ground	
28	VDD	Analog Voltage For Source Driver/Logic Voltage For Gate Driver	
29	VGON	Positive Voltage For Gate Driver	
30	VGOFF	Negative Voltage For Gate Driver	

Note 5-1:FPGA V_{CC}=+3.3V, ASIC V_{CC}=+5V

Note 5-2:Default is composite sync mode , if you uses separate mode , please contact PVI.

5.2) Display Mode

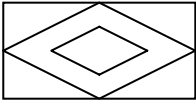
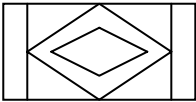
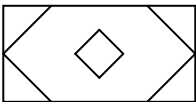
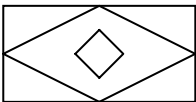
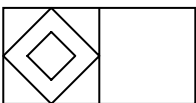
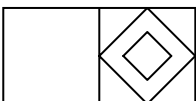
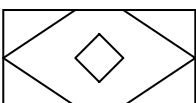
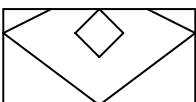
Display Mode	Display (Input Signal of 4:3 Aspect Ratio)	NO:11	NO:12	NO:13	Note
		Mode 1	Mode 2	Mode 3	
Full		Low	Low	Low	Input Video Signals Are Displayed In Full Screen.
Normal Center		High	Low	Low	Input Video Signals Are Displayed In The Center Screen.(4:3 Aspect Ratio)
Zoom 1		High	High	Low	Input Video Signal Of Central 176 Lines Are Display In Full Screen.(Vertically Extension)
Wide		Low	High	Low	Input Video Signals Are Displayed In Full Screen. (Horizontal Modification)
Normal Left		High	Low	High	Input Video Signals Are Display In the Left Screen. (4:3 Aspect Ratio) m
Normal Right		Low	High	High	Input Video Signals Are Display In the Right Screen. (4:3 Aspect Ratio)
Zoom 2		Low	Low	High	Input Video Signal Of Central 204 Lines Are Display In Full Screen.(Vertically Extension)
Zoom 3		High	High	High	Same As Zoom 2 Mode Vertically Offset Centered



6 Absolute Maximum Ratings:

The followings are maximum values , which if exceeded, may cause faulty operation or damage to the unit.

Parameter	Symbol	MIN.	MAX.	Unit	Remark	
Supply Voltage For Source Driver	V _{DD}	-0.5	7	V		
Supply Voltage For Gate Driver	H Level	V _{GON}	0	40	V	
	L Level	V _{GOFF}	-20	0	V	
Analog Input Voltage	V _R ,V _G ,V _B	-0.3	7.0	V		
Digital Input Signals		-0.5	5.5	V		
Digital Output Signals		-0.5	5.5	V		
Storage Temperature		-30	+80	°C		
Operation Temperature		-20	+70	°C		

7 Electrical Characteristics

7-1)Driving for TFT-LCD panel

		Symbol	MIN.	Typ	MAX	Unit	Remark
Supply Voltage For Source Driver	Analog	V _{DD}	4.5	5.0	5.5	V	
	Logic	V _{CC}	3.0	3.3	3.6	V	
Supply Voltage For Gate Driver	H level	V _{GON}	+15	+17	+19	V	
	L level	V _{GOFF}	-14	-12	-10	V	
Supply Voltage For controller		V _{DD}	4.5	5.0	5.5	V	
Analog input voltage	Amplitude						
	AC com						
Digital input voltage	H level	V _{IN}	+2.4	-	5	V	
	L level	V _{IL}	-0.3	-	0.5	V	
Digital output voltage	H level	V _{OH}	+2.4		5	V	
	L level	V _{OL}	0		0.5	V	

7-2) Backlight driving & Power Consumption

Pin No	Symbol	Description	Remark
1	VL1	Input terminal (Hi voltage side)	
2	VL2	Input terminal (Low voltage side)	Note 7-1

Note 7-1 : Low voltage side of backlight inverter connects with Ground of inverter circuits.



Driving for backlight

Ta= 25

Parameter	Symbol	Min.	Typ.	Max.	Unit	Remark
Lamp voltage	V_L	480	520	560	Vrms	$I_L=6mA$
Lamp current	I_L	4	6	8	mA	
Lamp frequency	P_L	20		60	KHz	Note 7-2
Kick-off voltage	V_s			1500	Vrms	
Kick-off voltage(-20)	V_s			TBD	Vrms	

Note 7-2 : The wave form of lamp driving voltage should be as closed to a perfect SIN wave as possible.

Power Consumption

Ta= 25

Parameter	Symbol	Conditions	TYP.	MAX	Unit	Remark
LCD Panel Power Consumption			TBD		W	Note 7-3
Backlight Lamp Power Consumption			4.2		W	Note 7-4

Note 7-3 : The power consumption for backlight is not included.

Note 7-4 : Backlight lamp power consumption is calculated by $I_L \times V_L$.

7-4) Input / Output Connector

A) LCD Module Connector

The interface connector is 6210-30p Series manufactured by Elco or equivalent (0.5mm pitch 30pin)

B) Backlight Connector, JST BHR-03VS-1. Pin No. : 3, Pitch : 4 mm

7-5) Pixel Arrangement and Output Interface Pin

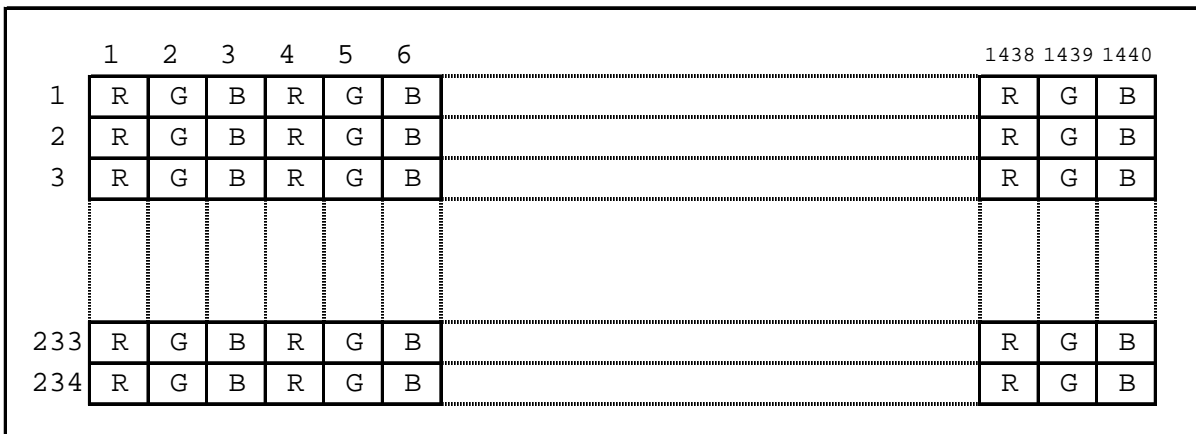



7-6)Signal Timing Waveforms
Timing Specification
[Horizontal]

Parameter	Symbol	Condition	NTSC	PAL	Unit	Notes
Horizontal Start Position	HPOS	-	11.35	11.54	usec	Note7-5
Horizontal Display Area	HDIS	-	50.01	50.36	usec	

Notes :7-5

1. Sampling start based on the composite sync falling edge.
2. This value is default , if you want to charge ,please contact PVI.

[Vertical]

Parameter	Symbol	Condition		Display Mode					Unit	Notes
				Full Normal	Wide	Zoom 1	Zoom 2	Zoom 3		
Vertical Start Position	VPOS	NTSC	ODD EVEN	20 286	20 286	52 315	38 301	53 315	Line	Note 7-6
		PAL	ODD EVEN	26 339	26 363	62 375	50 363	62 375	Line	Note 7-6
Vertical Display Position	VDIS	NTSC		234	234	176	204	204	Line	
		PAL		281	281	210	234	234	Line	

Notes :7-6 Sampling start line number base on the vertical sync pulse (SYNC).

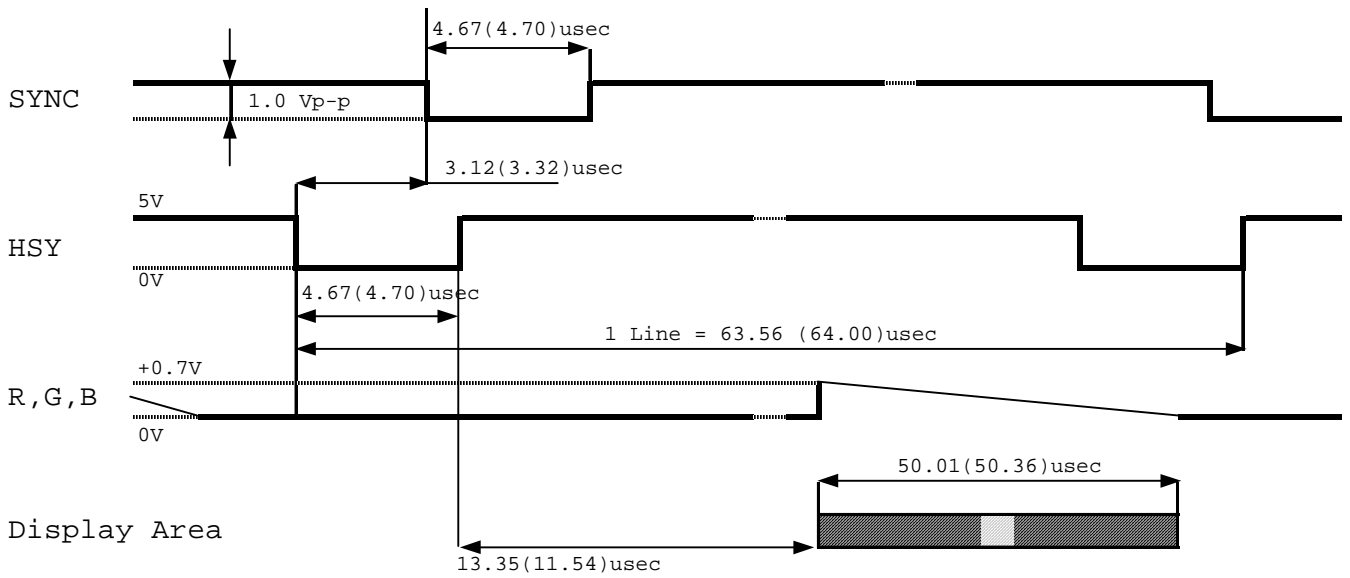

Note:7-7 Values in brackets correspond to PAL mode (f_H=15.734(15.625)KHz).

7-7) Display Time Range

A) When sync. signal of NTSC system is applied.

- a) Horizontally
11.35 ~ 63.4 µ s.
- b) Vertical
20 ~ 253 H

B) When sync. signal of PAL system is applied.

- a) Horizontally
11.54.0 ~ 64 µ s .
- b) Vertical
26 ~ 298 H

C) NTSC System Timing Reference

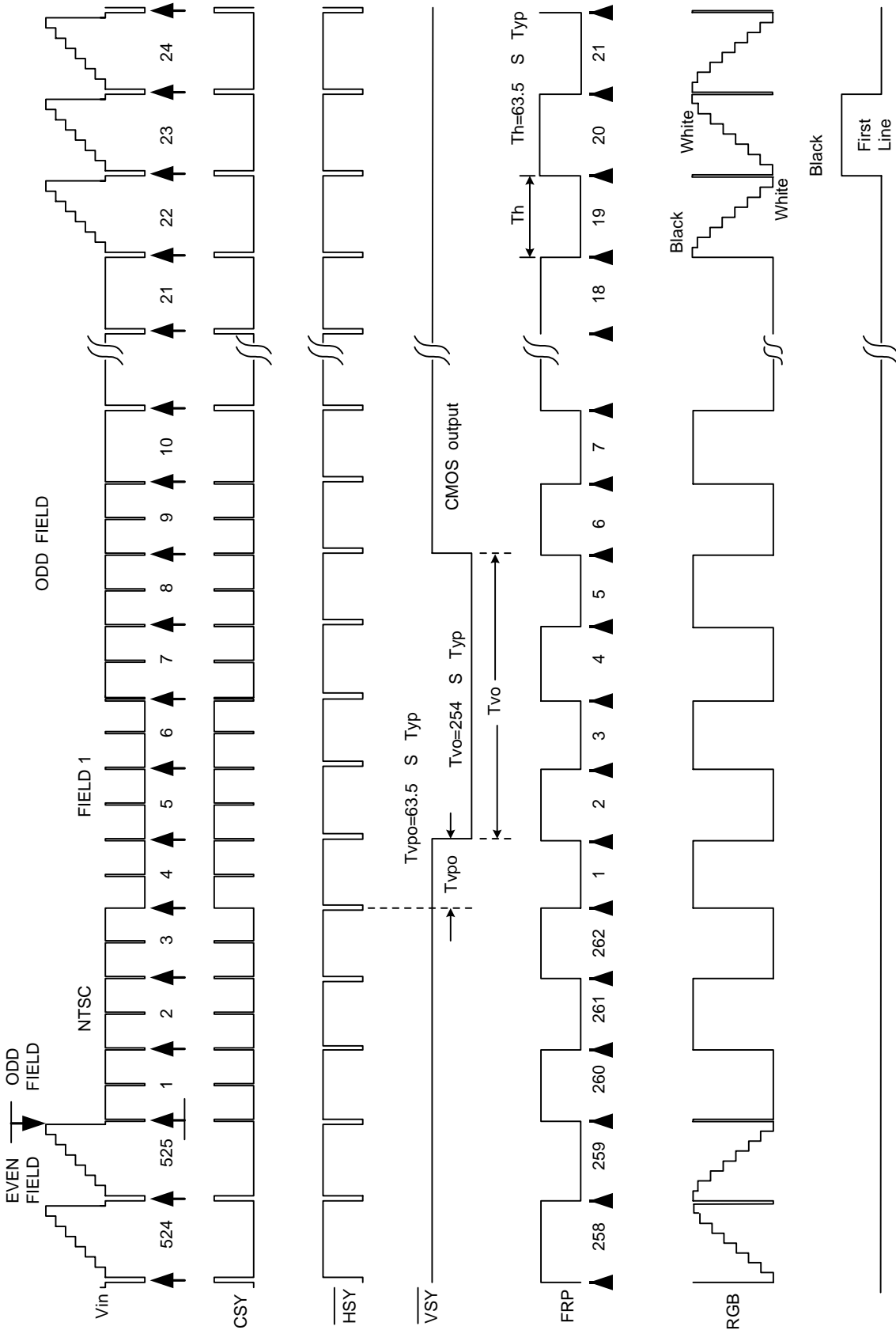

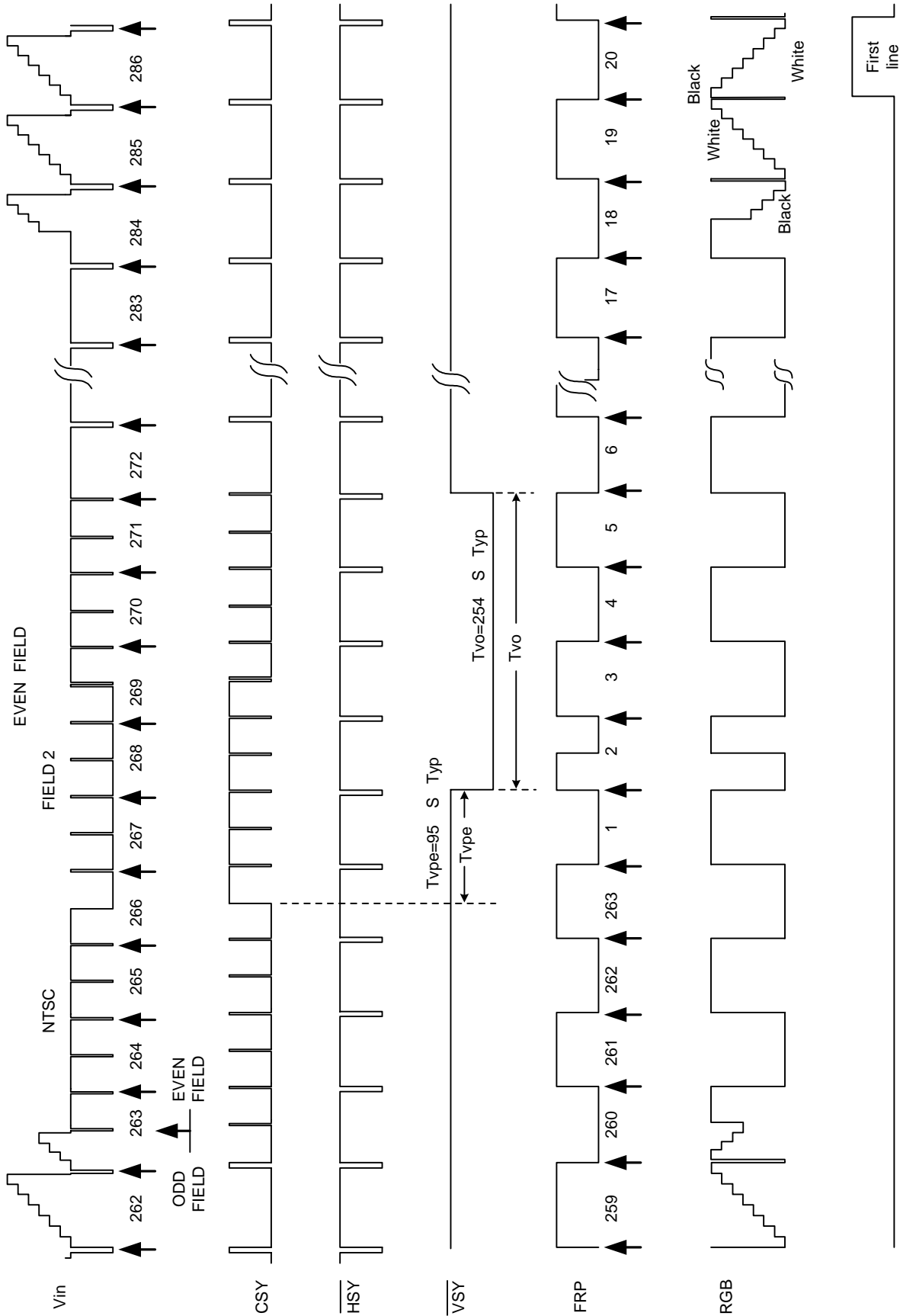

Timing chart of I/O and RGB signal

D) PAL System Timing Reference

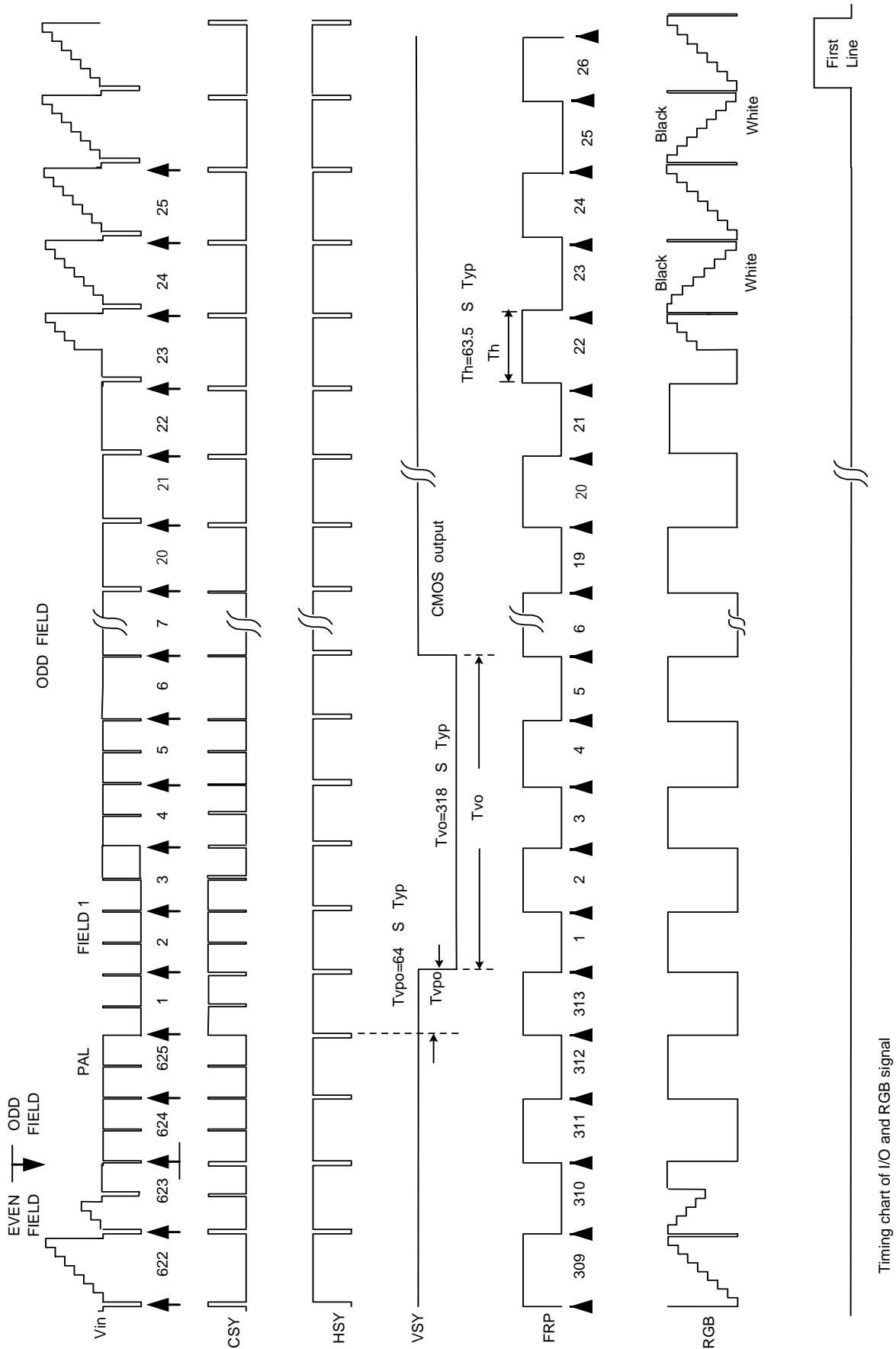

Timing chart of I/O and RGB signal

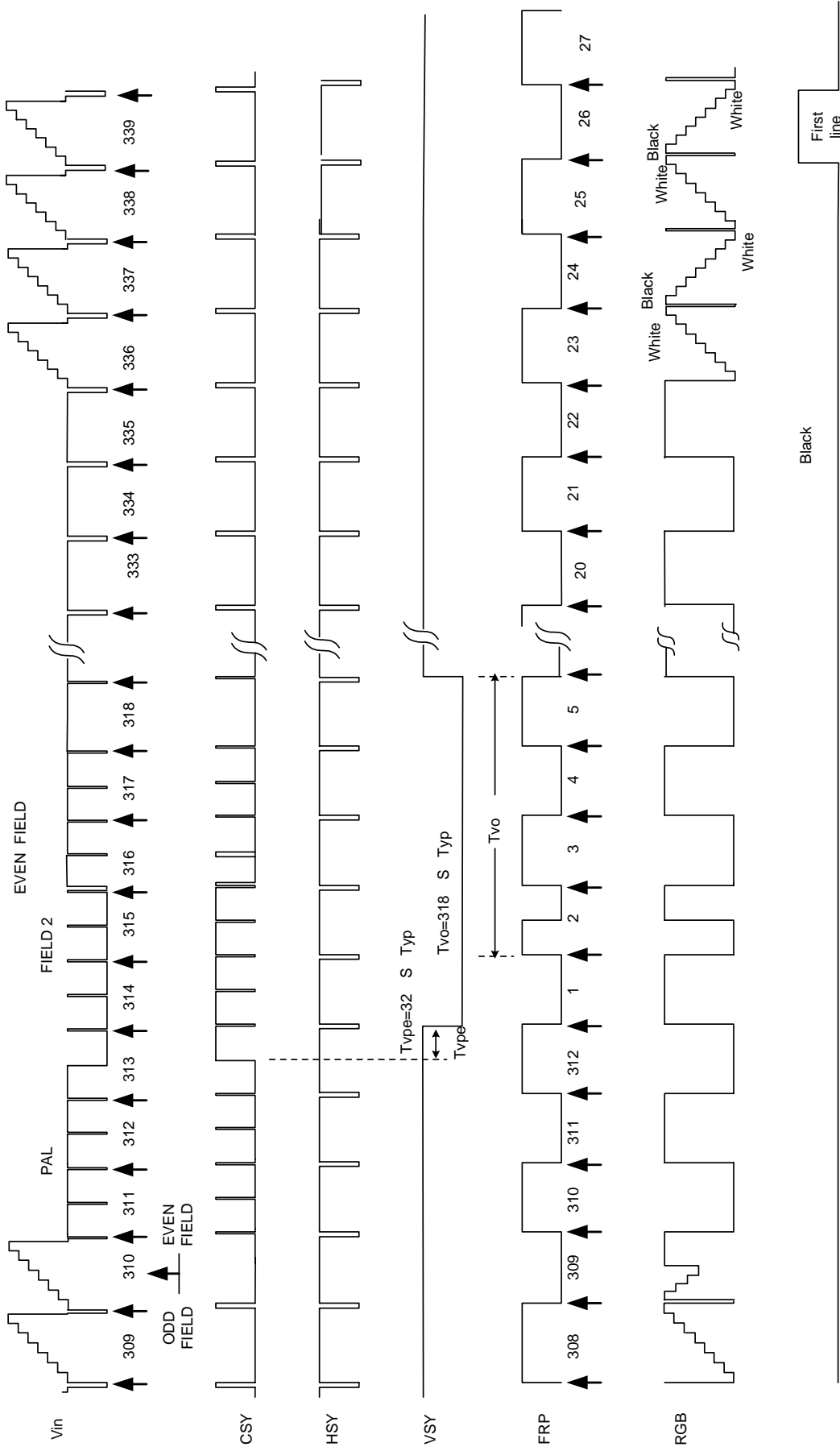

Timing chart of I/O and RGB signal

E) Display Timing (NTSC&PAL)

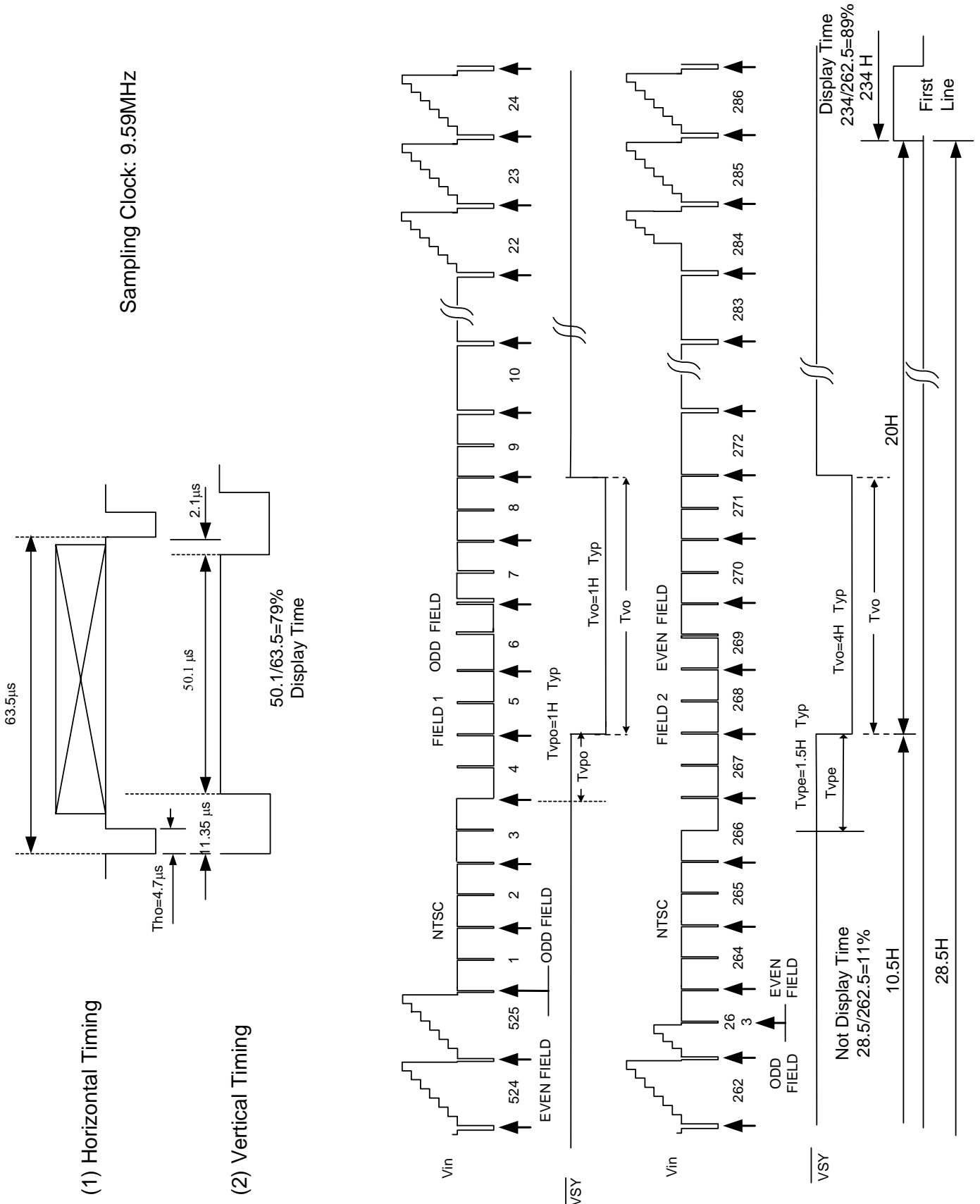

8. Power Sequence

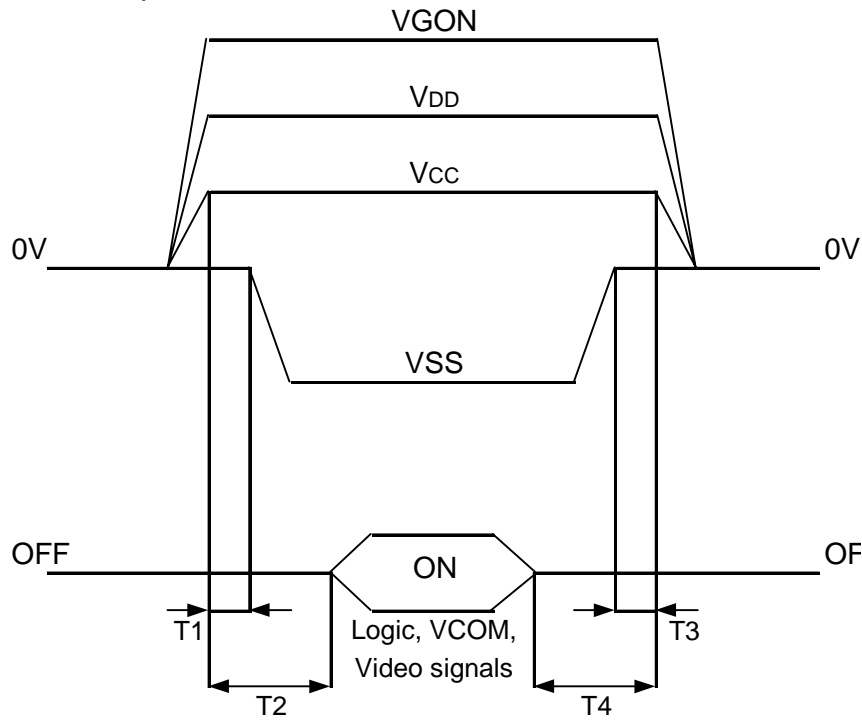

- 1) $10 \text{ msec} \leq T1 < T2, 0 < T3 < T4 \leq 10 \text{ msec}$
- 2) Vcc, VDD, VGON

9. Optical Characteristics

9-1) Specification:

Ta = 25

Parameter		Symbol	Condition	MIN.	TYP.	MAX.	Unit	Remarks
Viewing Angle	Horizontal	θ_{21}, θ_{22}	$CR \geq 10$	45	55		deg	Note 9-1
	Vertical	θ_{12}		10	15		deg	Note 9-1
		θ_{11}		30	35		deg	Note 9-1
Contrast Ratio		CR		80	150			Note 9-2
Response time	Rise	Tr	$\theta = 0^\circ$			30	ms	Note 9-4
	Fall	Tf				50	ms	
Brightness				300	350		cd/m ²	Note 9-3
White Chromaticity		x						Note 9-3
		y						
Lamp Life Time				10,000			hr	

Note 9-1: The definitions of viewing angles

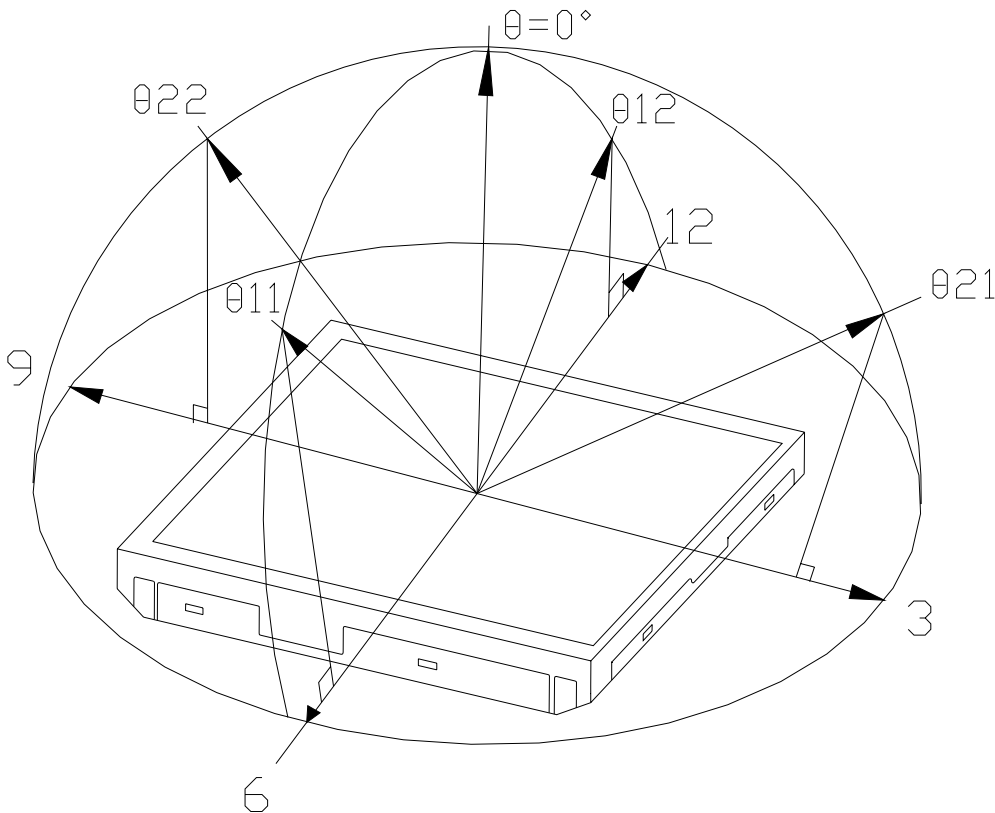

Note 9-2 : $CR = \frac{\text{Luminance when Testing point is White}}{\text{Luminance when Testing point is Black}}$
(Testing configuration see 8-2)

Contrast Ratio is measured in optimum common electrode voltage.

Note 9-3 : Topcon BM-7(fast) luminance meter 2°field of view is used in the testing (after 20~30 minutes operation).
Lamp Current 6mA

Note 9-4: The definition of response time:

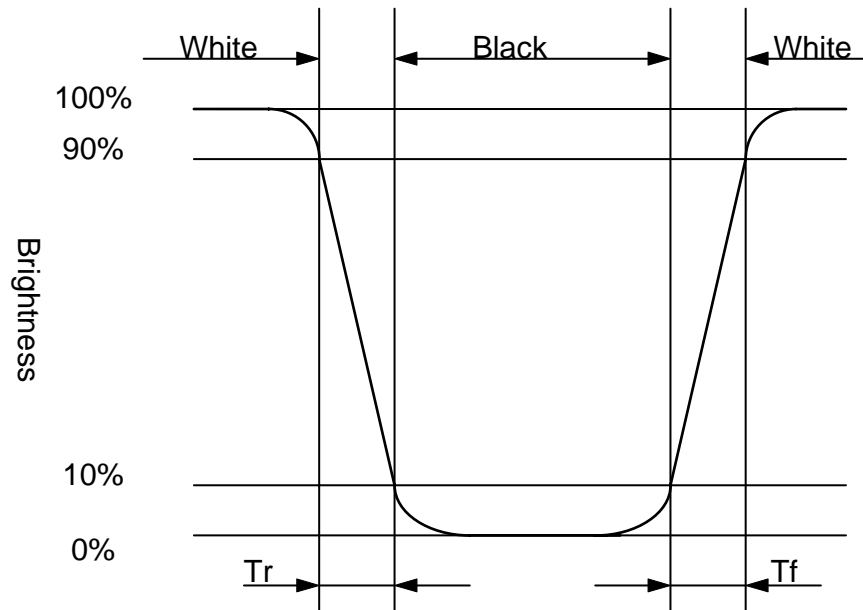

9-2) Testing configuration

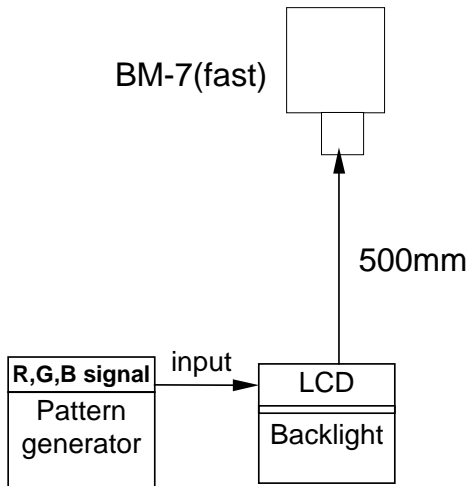

Caution: 1. Environmental illumination 1 lux
 2. Before test CR, Vcom voltage must be adjusted carefully to get the best CR.

- LCD Display Testing Point Testing Point

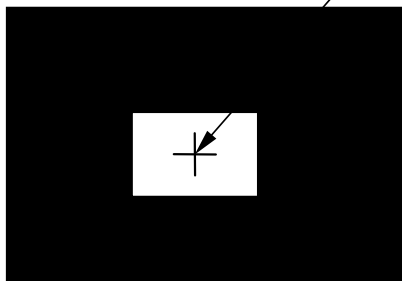

Pattern A

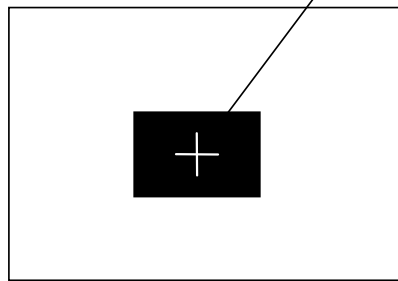

Pattern B

- R, G, B Waveform of Pattern A at Testing Point

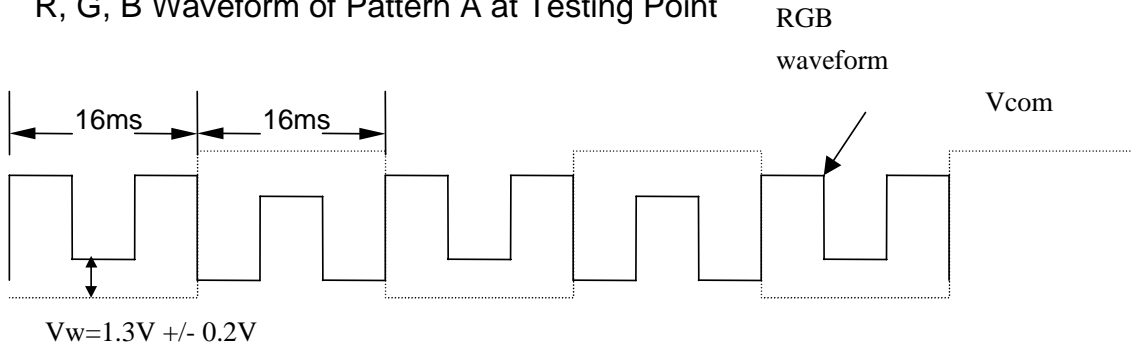

- R, G, B Waveform of Pattern B at Testing Point

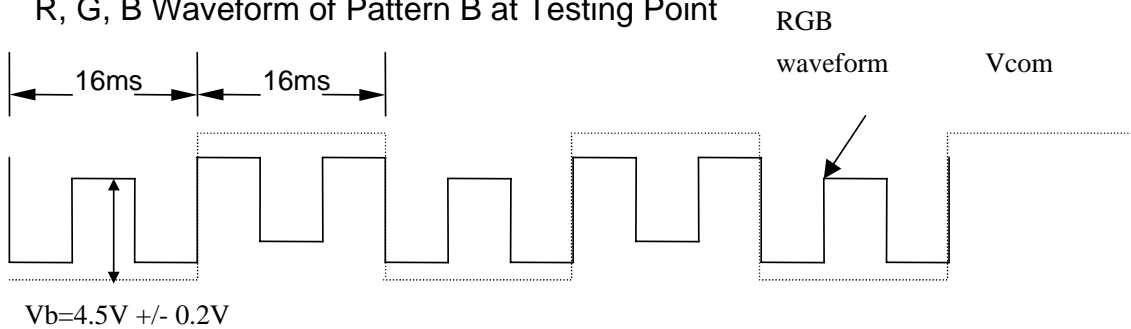



10. Reliability Test

No	Test Item	Test Condition
1	High Temperature Storage Test	Ta = +80 , 240 hrs
2	Low Temperature Storage Test	Ta = -30 , 240 hrs
3	High Temperature Operation Test	Ta = +70 , 240 hrs
4	Low Temperature Operation Test	Ta = -20 , 240 hrs
5	High Temperature & High Humidity Operation Test	Ta = +60 , 95%RH, 240 hrs
6	Thermal Cycling Test (non-operating)	-25 +25 +70 , 200 Cycles 30 min 5min 30 min
7	Vibration Test (non-operating)	Frequency : 10 ~ 55 Hz Amplitude : 1.0 mm Sweep time: 11 mins Test Period: 6 Cycles for each direction of X, Y, Z
8	Shock Test (non-operating)	100G, 6ms Direction: ±X, ±Y, ±Z Cycle: 3 times
9	Electrostatic Discharge Test	150pF, 330 Air: ±15KV; Contact: ±8KV 10 times/point, 9 points/panel face

Ta: ambient temperature

[Criteria]

Under the display quality test conditions with normal operation state, there should be no change which may affect practical display function.

12. Packing

REV.	ECN NO.	DESCRIPTION	DESIGN	CHECK	APPROVE	DATE
		INITIAL RELEASE				2006/1/24

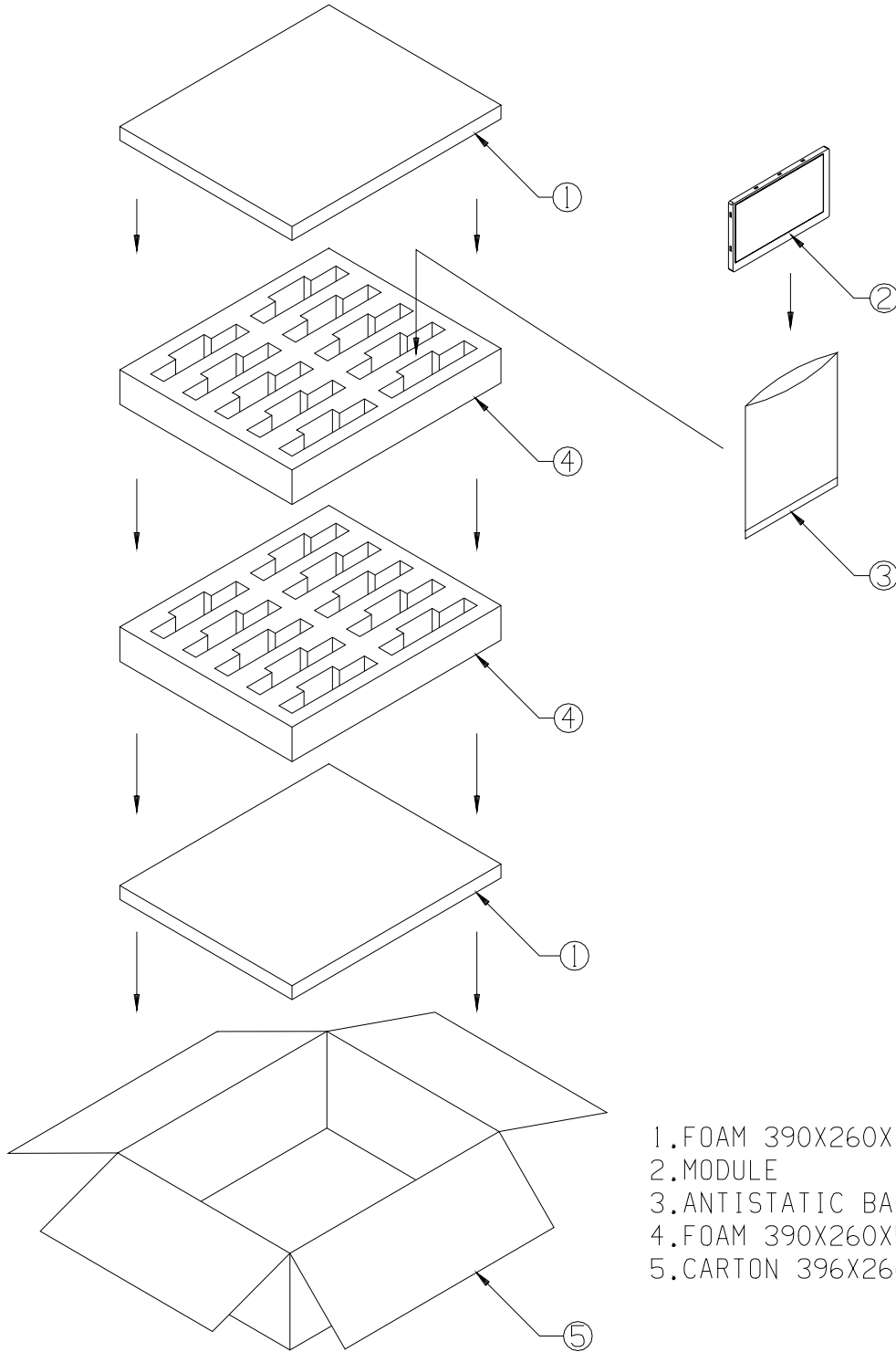



- 1.FOAM 390X260X30
- 2.MODULE
- 3.ANTISTATIC BAG 180X200
- 4.FOAM 390X260X55
- 5.CARTON 396X266X188

MATERIAL		HEAT & SURFACE TREATMENT		Prime View International Co., Ltd.		
APPROVE		SCALE	UNIT	PROJECTION METHOD	DWG. NAME	
CHECK		1/1	mm		PACKING_71	
DESIGN		ORIGINAL NAME		DWG. NO.	REV.	SHEET
						1/1

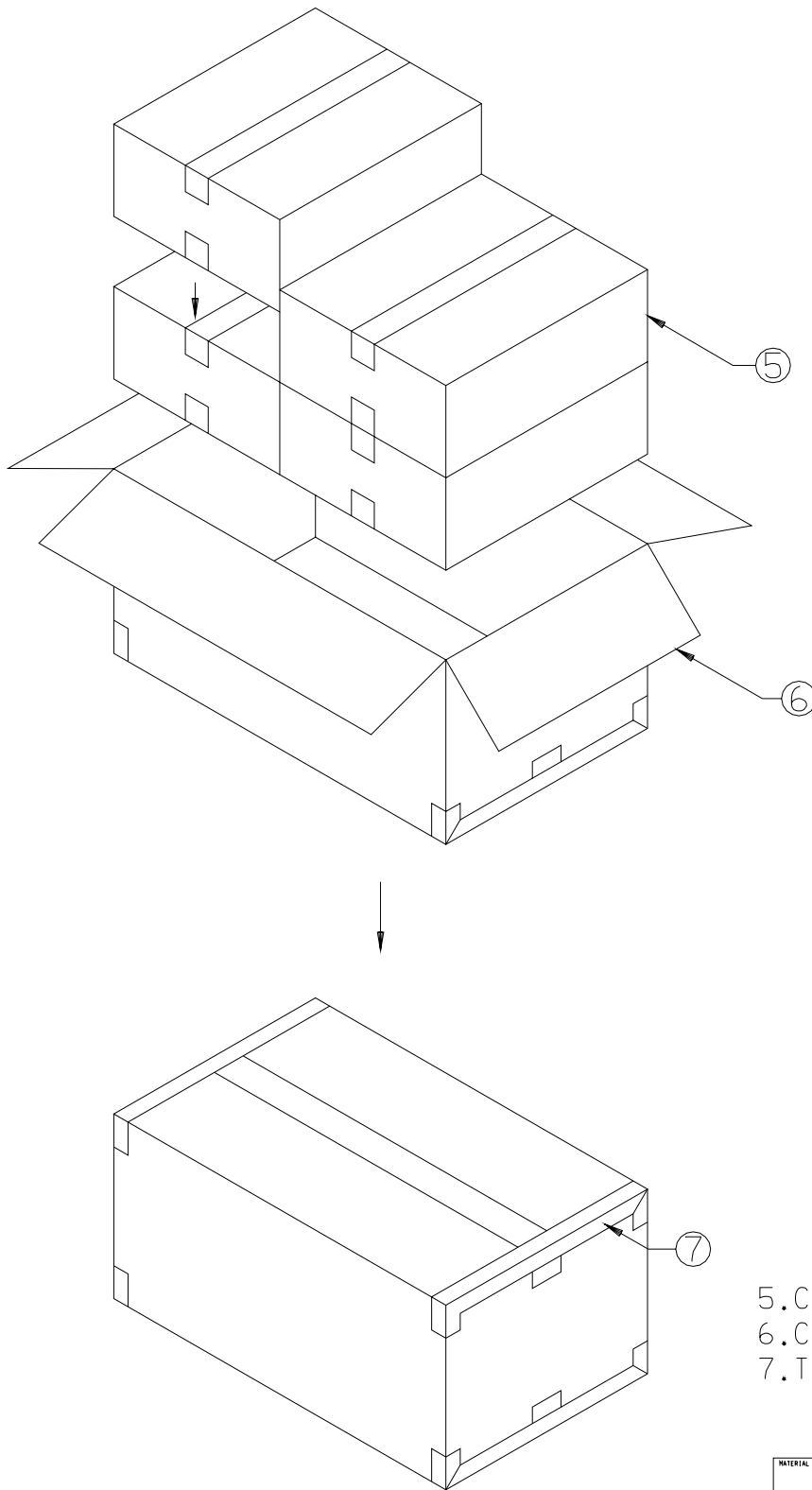
REV.	ECN NO.	DESCRIPTION	DESIGN	CHECK	APPROVE	DATE
		INITIAL RELEASE				2000.4.24



- 5. CARTON 396X266X188
- 6. CARTON 558X418X415
- 7. TAPE

MATERIAL		HEAT & SURFACE TREATMENT		 Prime View International Co., Ltd.		
APPROVE	SCALE	UNIT	PROJECTION METHOD	DWG. NAME		
CHECK	1/1	**		PACKING.7"		
DESIGN	ORIGINAL NAME		DWG. NO.	REV.	SHEET	
					2/2	



Revision History

Rev.	Issued Date	Revised Contents
0	FEB. 02,2000	NEW